

WHEELED EXCAVATOR  
**HW210A**

Operating weight: 21200 kg  
Engine power: 145 kW (195 HP) / 2200 rpm  
Bucket capacity: 0.80 m<sup>3</sup> - 1.34 m<sup>3</sup>



# A IM HIGH



## Take your performance to the next level!

Hyundai Construction Equipment has raised the benchmark again with a new series of wheeled excavators that give you the edge in numerous on-road and off-road applications. Our A-Series machines comply with EU Stage V emissions regulations while delivering higher performance, better fuel efficiency, superior travel speed on the road, an improved cabin and added safety features.

Featuring a new, compact rear design and enhanced controllability, the HW210A is a real heavy-duty all-rounder! Ideally suited to road, pipeline and canal construction and earth-moving work, it also capably handles trenching, digging, dozing, drilling, cutting, lifting and site preparation. Set your sights on higher efficiency and outstanding results.

**Together, we can move mountains!**

Productivity & Efficiency

# AIM FOR SUPERIOR PERFORMANCE

... with effortless power.

From its upgraded, eco-friendly engine to its carefully chosen control technologies, the HW210A wheeled excavator helps operators to achieve new heights of productivity. Hyundai's EPFC hydraulic system in connection with variable power control allows the machine to deliver the exact performance when and where needed. The HW210A is the right machine for heavy-duty applications where manoeuvrability matters.



NEW

**High-performance Stage V engine**  
The HW210A is equipped with a fuel-efficient Cummins B6.7 Stage V engine that meets the world's strictest emission regulations. Its compact 6-cylinder configuration delivers impressive power and performance with 31% more peak torque and 5% more peak power than its predecessor.

↑  
**14% FUEL SAVINGS**  
vs HW210 predecessor  
**+31% PEAK TORQUE**  
**+5% PEAK POWER**  
vs predecessor

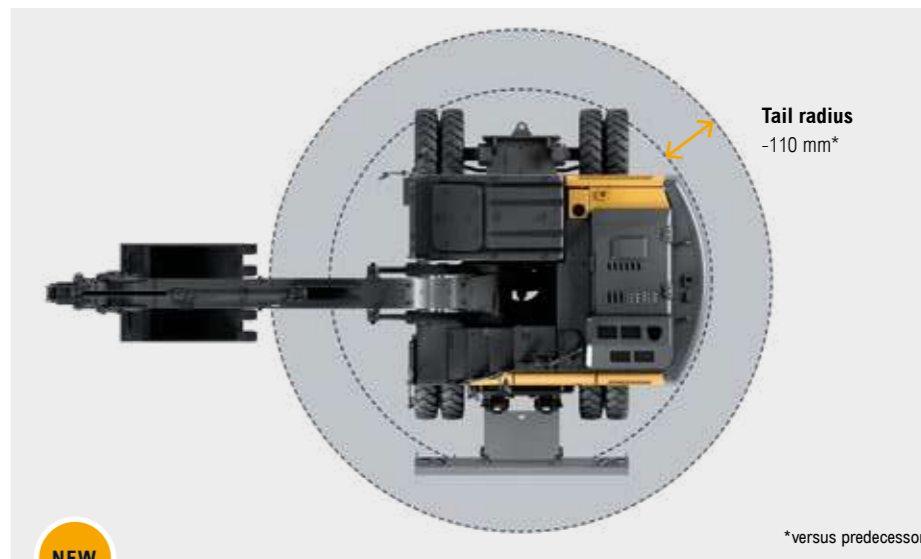

NEW

Tail radius  
-110 mm\*

\*versus predecessor

**Eco gauge**

This feature helps operators to reduce emissions and running costs by constantly monitoring efficiency. It displays engine workload and fuel-saving status while the machine is working.

**Reduced tail radius**

The HW210A tail radius has been reduced by 110 mm (from 2850 mm to 2740 mm). This helps operators to work safely, confidently and efficiently in confined spaces and busy construction environments.

**Engine auto-idle**

The auto-idle feature saves fuel, reduces noise and cuts exhaust emissions by automatically switching the engine to idle setting when the excavator is inactive. This reduces fuel consumption without affecting productivity.

**Advanced exhaust aftertreatment**

Our all-in-one exhaust aftertreatment module combines a DOC, SCR and DPF in one unit. EGR-free and featuring DPF auto-regeneration, this simplified system is more robust and requires less maintenance. Removing the need for EGR has also enabled us to improve productivity through better fuel economy and longer service intervals.

**Hydrostatic 4-wheel drive**

The 4-wheel hydrostatic drive system ensures a smooth driving experience, even in rough conditions.



NEW

**EPFC (Electronic Pump Flow Control)**

EPFC improves fine control while also reducing fuel consumption. The advanced hydraulic system and controls allow operators to tailor performance for the job at hand, ensuring the optimal balance of power and precision.

**Proportional auxiliary hydraulics**

Productivity is further enhanced by a proportional auxiliary hydraulics system. A proportional single or double-acting circuit is installed as standard, enabling smooth, precise control of attachments.



**Productivity & Efficiency**

# AIM FOR MAXIMUM RETURN ON INVESTMENT

with the flexibility to tackle any job.



**Undercarriage support options**

The HW210A can be equipped with various combinations of front and rear outriggers or a dozer blade, allowing for tailored support to enhance stability as required by the work environment.



**Electronically controlled reversible fan**

The reversible fan is electronically controlled to provide automatic engine cooling. An improved self-cleaning fan mode efficiently eliminates dust and debris, protecting performance and productivity.

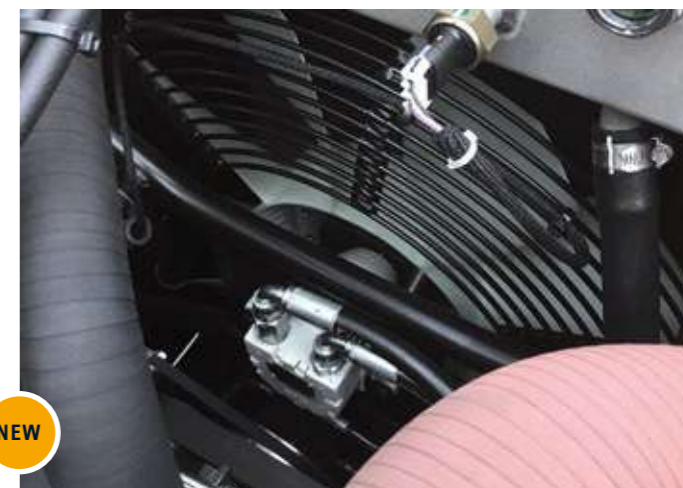

**Tiltrotator**

A factory-mounted Engcon tiltrotator is available as an option, boosting efficiency and profitability through enhanced control with lower fuel consumption.



**2D and 3D grading**

Your HW210A wheeled excavator can be supplied with factory-prepared 2D or 3D-ready Machine Control or Machine Grading systems. This gives you the flexibility to work on a wider range of job sites and applications.

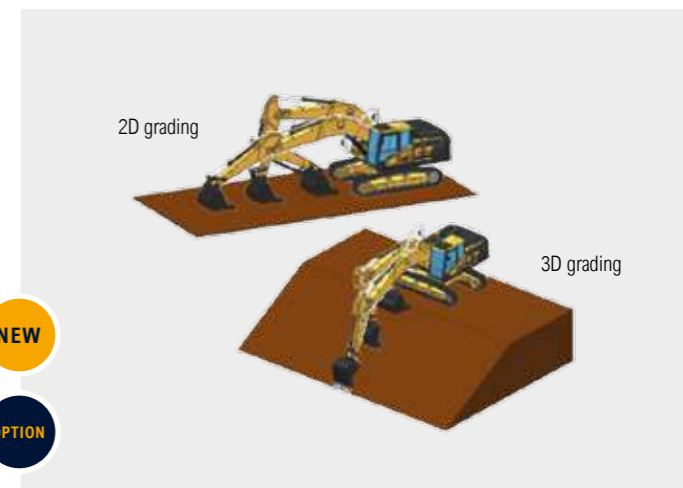

**Durability**

# AIM FOR MORE UPTIME AND DRIVING PLEASURE

**... with robust construction and reliable components.**

Hyundai has always been driven by the goal of providing durable machines that will create the ultimate long-term ownership experience for our customers. As well as improving engine reliability and simplifying the exhaust aftertreatment system, we have reinforced and optimised numerous other components to extend the lifetime of our A-Series wheeled excavators. Our ultimate aim is to minimise downtime and repairs so that you can stay on schedule, avoid unexpected costs and protect your profits.



**Hi-grade (high-pressure) hoses**

High-grade hoses with outstanding resistance to heat and pressure provide maximum durability with low maintenance, even in demanding conditions.

**Durable cooling module**

The HW210A is equipped with a new, stacked-type, easy-clean cooling module with a hydraulically driven reversible fan. As well as improving durability, it optimises fuel economy and noise reduction.



**Centralised greasing system**

A centralised automatic greasing system can be installed as an option. This optimises daily maintenance to prolong the life of all machine joints.

OPTION



**Reinforced pins, bushings and polymer shims**

The reinforced pins, bushings and polymer shims are designed for an extended lifetime with less maintenance, reducing overall ownership costs.

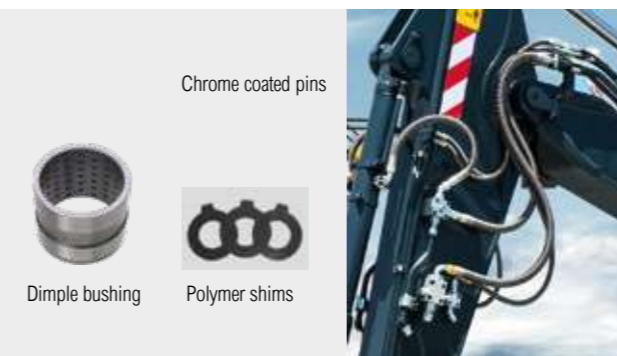

**Reinforced upper and lower frame structure**

Built for unbeatable strength and sturdiness, the HW210A offers solid performance over a long lifetime. The upper and lower frame structures are reinforced for high workload, while the attachments have been rigorously tested for the roughest conditions.



**Operator comfort**

# AIM FOR MORE COMFORT AND CONVENIENCE

**...with a spacious cabin and improved ergonomics.**

It's easier to be productive when your workplace is comfortable and well designed.

That's why we placed operators right at the centre of the HW210A cabin design. Light and spacious, it features a high-quality, adjustable seat and an ergonomic layout that places controls within easy, comfortable reach. Numerous features have been added to enhance convenience, reduce fatigue and promote efficiency.

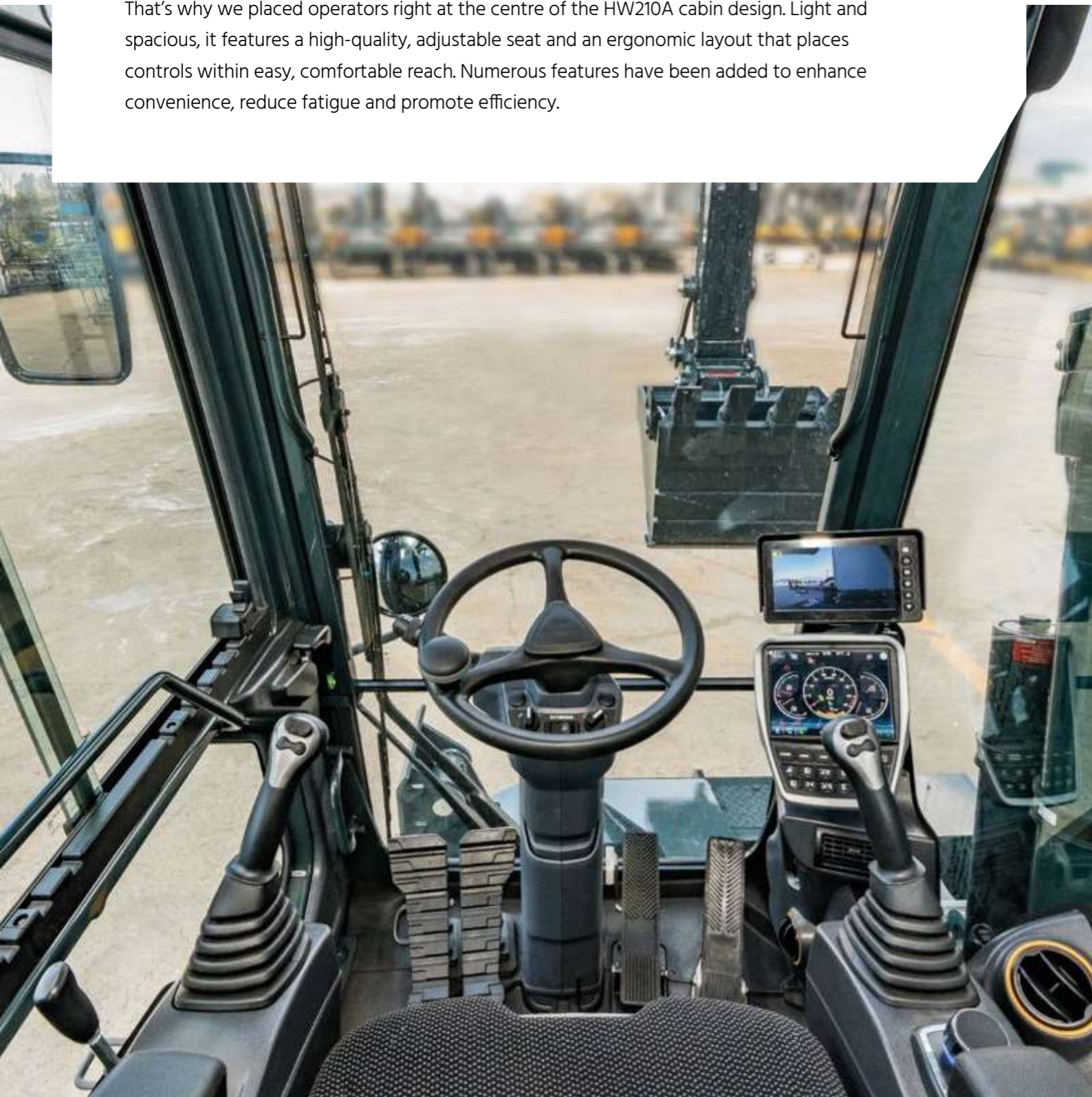

**3-way adjustable steering column**

The steering column is ergonomically positioned and adjustable so that every operator can work more comfortably and productively.



**Work modes**

The operator can select from three different work modes – Park, Work and Travel – for convenient automatic control of a range of functions.



**Deluxe seat**

The air suspension seat is ergonomically designed and heated, helping operators to work longer without fatigue in all weathers and seasons.



**Full climate control**

The efficient air conditioning is enhanced with full climate control for fast heating, cooling and defrosting.



**Jog dial module**

For added convenience, an integrated jog dial module allows easy control of the air conditioning and instrument cluster navigation.

**Auxiliary joystick and pedal control**

A 2-way proportional auxiliary joystick and pedal control enable effortless operation to minimise operator fatigue.



**Joystick steering**

The HW210A features right-hand joystick steering, for quick, easy manoeuvring and enhanced productivity.



**FNR and Ram Lock Switch on joystick**

The Forward/Reverse switch is positioned right at the operator's fingertip. The front axle oscillation lock can also be activated from the joystick, improving convenience and productivity on demanding jobs.

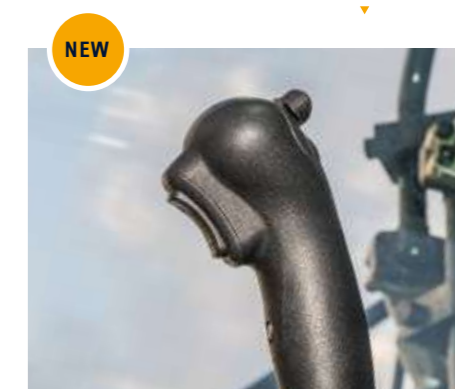

Operator comfort

# AIM FOR EASY, EFFICIENT CONTROL

.... with the right technologies to assist you.



**Wide touchscreen monitor**

The 8-inch touchscreen is one of the largest on the market and features WiFi connectivity, allowing operators to take advantage of smart technologies as they work.



**Advanced audio system**

The audio system includes a radio player, USB-based MP3 player and Bluetooth for hands-free calling. The smart display of the cabin monitor mirrors mobile phone functions, keeping operators entertained and connected all day long.



OPTION

**Attachment flow control**

Operators can choose the optimal flow rate setting via the cabin display to tailor attachment performance for a wide range of operations and environments. The machine memory accommodates 20 attachments (10 breaker types and 10 crusher types).



**Lifting mode and power boost function**

Lifting mode increases power and precision while reducing operating speed when lifting heavy loads. The power boost function automatically increases relief pressure for that extra push when you need it.



OPTION

NEW

**Air compressor**

An optional air compressor can be mounted in the cabin to help operators keep their workspace pleasant and comfortable.

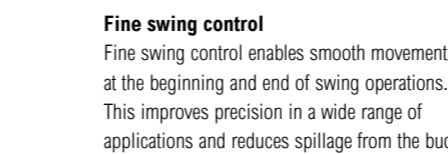

OPTION

**Fine swing control**

Fine swing control enables smooth movement at the beginning and end of swing operations. This improves precision in a wide range of applications and reduces spillage from the bucket.

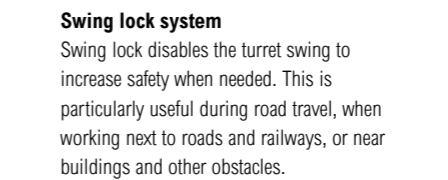

OPTION

**Swing lock system**

Swing lock disables the turret swing to increase safety when needed. This is particularly useful during road travel, when working next to roads and railways, or near buildings and other obstacles.

**Cruise control & speed limiter, creep speed drive**

The HW210A is equipped with cruise control and speed limiter systems, allowing operators to relax while maintaining a steady speed over longer distances. When creep speed is activated, the excavator will drive at a maximum speed of 3.5 km/hr. This gives the operator better control and higher torque with minimal effort.



## Safety

# AIM FOR THE HIGHEST PROTECTION FOR WORKERS

... with zero compromise on efficiency.

The Hyundai approach to safety goes far beyond just meeting regulatory standards. We prioritise safety in every aspect of our machines and work with our customers to keep improving protection for operators, co-workers, passers-by, surrounding buildings and of course the machines themselves. This includes robust, protective machine structures, a cabin design that offers a clear all-round view of machine surroundings and a series of additional features and technologies that increase peace of mind on and off the work site.



◀ **Safety valves on all cylinders**  
As a standard feature, safety valves are integrated on the boom, arm, blade and ram lock hydraulic cylinders.

◀ **LED lights**  
All the working lights are LED-type for greater visibility during work and travel.

NEW

◀ **Safety glass**  
Safety glass has been used for all windows, including a laminated glass front window for added protection

◀ **Cabin suspension mount**  
Integrated silencer blocks minimise noise and vibration inside the cabin, reducing fatigue and allowing safer, more enjoyable operation.

◀ **Improved cabin access**  
The cabin access steps have been redesigned for safe, convenient entry.

NEW



## Safety

### Advanced Around View Monitoring (AAVM)

Hyundai's AAVM camera system can be installed as an option, giving operators a 360° overview of their immediate working environment, including rear, side mirror and birds-eye views. It also integrates Intelligent Moving Object Detection (IMOD) technology that senses and warns the driver when people or objects come within five metres of the machine.



### Radar with second monitor

The radar system detects static or moving objects within a 10-metre radius of the rear of the excavator, day or night. Obstacles are displayed on a separate monitor giving operators maximum visibility.

### Auto safety lock

The auto safety lock feature prevents unintentional ignition and random machine movement. When the safety lever is unlocked, the engine cannot be started and the system will not engage, even if the joystick is pressed accidentally.

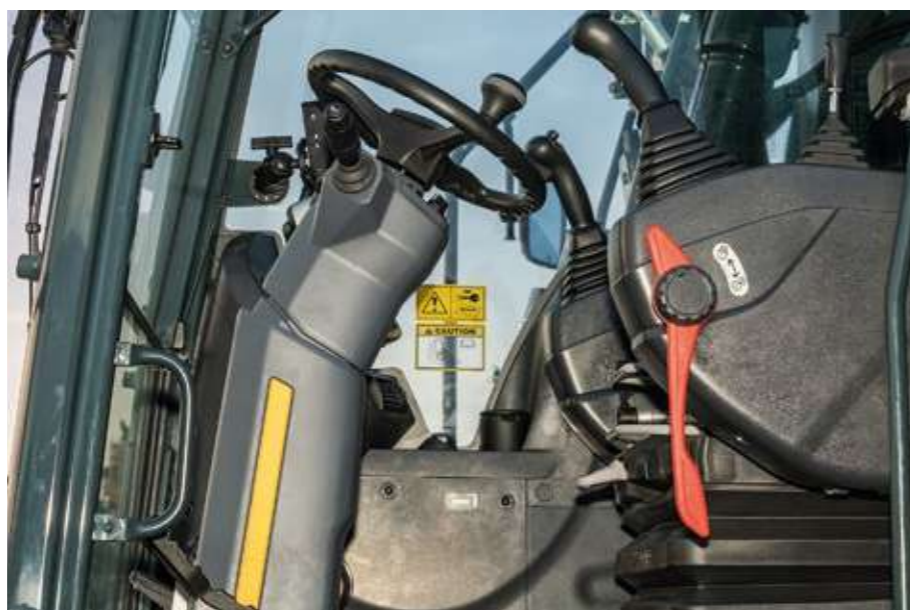

### Axles and fenders

The HW210A has been equipped with heavy duty rigid axles for higher durability and better stability in different conditions and material handling applications. Sturdy steel fenders have been added to protect the tyres from flying debris while driving.

### Emergency steering

If the hydraulic supply should fail, manual steering is automatically enabled.

### ROPS / FOPS certified cabin

To protect workers, the cabin structure is reinforced with integrally welded, low-stress, high-strength steel. It is certified to ISO 12117-2 (ROPS - Roll-over Protective Structures) and ISO 10262 Level 2 (FOPS - Falling Object Protective Structures) safety standards.

### Guard rail

A rigid or foldable guard rail can be fitted as an option to improve access to the upper structure and make moving around the machine safer and easier.

### New upper structure design

The upper structure has been redesigned to improve access for maintenance.



Serviceability & Connectivity

# AIM FOR MAXIMUM UPTIME AND EFFICIENT SERVICING

... with intelligent machine management and easy access.

Our A-Series wheeled excavators are designed with quick, low-effort servicing in mind. Every component and material has been optimised to ensure a long, trouble-free life. Hyundai's innovative Hi MATE telematics system enables full monitoring of machine activity and performance. Maximum connectivity is integrated to help owners create a smart construction site and protect profitability as their business grows.



OPTION

**Fuel filler pump**  
An integrated fuel filler pump with auto stop makes refuelling quick and easy.



**Mobile Fleet app**  
Hyundai's new Mobile Fleet app provides all the information you need to run your fleet efficiently and economically. Based on telematics, this advanced solution uses simple graphics and key performance data for smart fleet management.

**DEF/AdBlue filler access**  
Access to the DEF/AdBlue tank filling point has been made easier with redesigned steps.



## HiMATE Boost efficiency and performance

For maximum convenience and security, the HW210A features Hyundai's exclusive Hi MATE remote fleet management system, which uses mobile data technology to provide the highest level of service and support. You can monitor your equipment wherever you are via a dedicated website or mobile app, with access to working parameters like total engine hours, machine utilisation, actual performed working hours, fuel consumption and machine location.

**ECD (Engine Connected Diagnostics)**  
ECD provides troubleshooting advice as well as tailored servicing and parts support from Cummins Quick Serve. Service technicians are supported with remote diagnostics reports allowing them to prepare for initial site visits, bring the right tools and achieve a higher problem resolution rate.



**Increase productivity**  
By providing information such as service hours, idle time and fuel consumption, Hi MATE saves you money and improves productivity. Service alerts enable better maintenance planning.

**Monitor your machines**  
Hi MATE's real-time location information allows better, more convenient monitoring of your equipment. Just log onto the Hi MATE website or mobile app to see your machines at any time, from any location. Receive data online, by e-mail or directly on your mobile device.

**Improve security**  
Protect your equipment from theft or unauthorised usage. Hi MATE's geofencing alerts notify you automatically when a machine leaves a predetermined zone.

Take the tour!

# HW210A

## Productivity & Efficiency

- High-performing Stage V engine with advanced exhaust aftertreatment **NEW**
- EPFC (Electronic Pump Flow Control) system **NEW**
- Variable Power Control **NEW**
- Hydrostatic 4-wheel drive
- Eco gauge
- Electronically controlled reversible fan **NEW**
- Tiltrotator **NEW** **OPTION**
- 2D and 3D grading **NEW** **OPTION**

## Comfort

- 3-way adjustable steering column **NEW**
- Largest touchscreen monitor on the market (incl. WiFi)
- Attachment flow control
- Joystick steering **OPTION**
- FNR and Ram Lock Switch on Joystick **NEW**
- Cruise control & speed limiter
- Advanced audio system
- Full climate control



## Safety

- Advanced Around View Monitoring (AAVM) camera system **OPTION**
- Radar with second monitor **NEW** **OPTION**
- LED working lights
- ROPS / FOPS certified cabin
- Safety glass
- Wide axle and fenders **OPTION**
- Auto safety lock **NEW**
- Safety valves on all cylinders
- Automatic digging brake **NEW** **OPTION**

## Serviceability & Connectivity

- ECD (Engine Connected Diagnostics) **NEW**
- Improved DEF/AdBlue filler access
- Fuel filler pump with auto stop **OPTION**
- Hyundai Hi MATE telematics system
- Mobile Fleet app **OPTION**

## Durability

- Reinforced upper and lower frame structure
- Reinforced pins, bushings and polymer shims
- Durable cooling module
- Hi-grade (high-pressure) hoses
- Centralised greasing system **OPTION**

## Genuine parts and warranties

# THE BEST WAY TO PROTECT YOUR INVESTMENT

Hyundai Genuine Parts, accessories and warranty programmes are specially designed to keep your machine covered. They increase uptime and maintain the performance, comfort, and convenience that are built into your equipment.

### Fuel filters

Hyundai fuel filters provide the right degree of filtration to keep your engine clean. They are designed to meet and exceed the engine manufacturer's prerequisites for water separation and dirt filtration, prolonging the life of your engine.

### Aftermarket kits

You can order Hyundai aftermarket kits via your dealer. This AAVM system for example, improves safety in and around your work environment at all times.

### Hyundai Genuine Parts

Hyundai Genuine Parts have the same design as those installed when your machine left the factory. They are subjected to rigorous quality inspections and tests to make sure they meet Hyundai's strict requirements for quality and durability. As well as minimising downtime, this helps to ensure peak performance on every task.



## Hyundai warranties

Our warranties are designed to give you the cover you need to build your business with confidence and peace of mind.

### Standard warranties

We offer standard warranty coverage for all wheeled excavators. In addition, optional and extended warranty periods are available, so you can benefit from full warranty coverage for longer, and even over the full lifetime of the machine. Please discuss the optimal solution for your needs with your local Hyundai dealer.

### Extended warranties

Our extended warranties help you maintain full control over your operating costs. If you combine an extended warranty programme with a tailored maintenance contract, you can completely avoid unexpected costs.



## A network you can rely on

Hyundai Construction Equipment Europe prioritises quick, reliable intervention to keep your equipment running reliably. In its 13000 m<sup>2</sup> warehouse, Hyundai covers over 96% of all Genuine Parts. With one of Europe's most advanced automated warehousing systems, we are able to maintain availability and efficient delivery of all our Genuine Parts. Moreover, we guarantee a 24-hour delivery service across our European dealer network.

# SPECIFICATIONS

ENGINE	
Maker / Model	CUMMINS / B6.7
Type	6 cylinder, turbocharged, charge air cooled, electronic controlled diesel engine
Gross Power	129 kW (173 hp) at 2200 rpm
Net Power	127 kW (170 hp) at 2200 rpm
Max. Power	145 kW (195 hp) at 2200 rpm
Peak Torque	881 N·m at 1300 rpm
Displacement	6700 cc

HYDRAULIC SYSTEM	
EPFC - Electronic Pump Flow Control	
Type	Piston pumps
Max. flow	2 X 208 lpm
Sub-pump for pilot circuit	Gear pump
Cross-sensing and fuel saving pump system	

HYDRAULIC MOTORS	
Travel	Two speed axial pistons motor with brake valve and parking brake
Swing	Axial piston motor with automatic brake

RELIEF VALVE SETTING	
Implement circuits	350 kgf/cm <sup>2</sup>
Travel	380 kgf/cm <sup>2</sup>
Power boost (boom, arm, bucket)	380 kgf/cm <sup>2</sup>
Swing circuit	265 kgf/cm <sup>2</sup>
Pilot circuit	40 kgf/cm <sup>2</sup>
Service valve	Installed

HYDRAULIC CYLINDERS	
No. of cylinder bore x stroke	Boom: 2-120 x 1275 mm
	Arm: 1-140 x 1510 mm
	Bucket: 1-120 x 1055 mm
	Dozer Blade: 2-125 x 252 mm
	Outrigger: 2-130 x 436 mm
	2-PCS boom: 2-120 x 1080 mm
	Adjust (boom): 1-170 x 720 mm

\* Hyundai Bio Hydraulic Oil (HBHO) available.

DRIVES & BRAKES		
4-wheel hydrostatic drive. Constant mesh, helical gear transmission provides 2 forward and reverse travel speeds.		
Max. drawbar pull	12106 kgf	
Travel speed	1st	9.5 km/h
	2nd	38.4 km/h
Gradeability	35° (70 %)	

Service Brake :

\* Independent dual brake, front and rear axle full hydraulic power brake.

\* Spring released and hydraulic applied wet type multiple disc brake.

Parking Brake :

\* Spring applied and hydraulic released wet disc brake type in transmission.

CONTROLS	
Pilot control	Two joysticks with one safety lever
	(LH): Swing and arm,
	(RH): Boom and bucket (ISO)
Attachment Control	FNR switch on RH joystick / Ram lock switch on LH joystick
	3 modes available: Push / Proportional / Permanent
Engine throttle	Electric, Dial type
Operation Mode	3 modes available: P-Parking W-Working T-Travel

AXLE & WHEELS	
Full floating front axle is supported by center pin for oscillation. Oscillation lock (ram lock) function for safe operation. Rear axle is fixed on the lower chassis.	
Tyres	10.00-20-14PR, Dual (tube type)
(Optional)	10.00-20, Dual (solid type)
	10.00-20-16PR, Dual (tube type)

STEERING SYSTEM	
Hydraulically actuated, orbitrol type steering system actuates on front wheels through steering cylinders.	
Min. turning radius	6690 mm

SWING SYSTEM	
Swing motor	Fixed displacement axial pistons motor
Swing reduction	Planetary gear reduction
Swing bearing lubrication	Grease-bathed
Swing brake	Multi wet disc
Swing speed	10.87 rpm

COOLANT & LUBRICANT CAPACITY		
	liter	
Fuel tank	310.0	
Engine coolant	40.0	
Engine oil	24.4	
Swing device	6.2	
Axle	Front	14.6
	Rear	18.5
Transmission	2.5	
Hydraulic system (including tank)	340.0	
Hydraulic tank	165.0	
DEF/AdBlue®	48.0	

UNDERCARRIAGE	
Reinforced box-section frame is all-welded, low-stress. Dozer blade and outriggers are available by pin-on design.	
Dozer blade	Parallelogram-mounted dozer blade to support machine when working, also for leveling and back filling.
Outrigger	Indicated for max. operation stability when digging and lifting. Can be mounted on front/or rear.

OPERATING WEIGHT (APPROXIMATE)		
Operating weight, including 5650 mm Mono boom or 5400 mm 2-Piece boom, 2920 mm arm, SAE heaped 0.80 m <sup>3</sup> bucket, lubricant, coolant, full fuel tank, hydraulic tank and standard equipment.		
OPERATING WEIGHT		
Undercarriage	Mono boom	2-Piece boom
Front grab rest and rear dozer blade	21280 kg	22510 kg
Front outriggers and rear blade	22360 kg	23690 kg
Front blade and rear outriggers	22510 kg	23840 kg
Front and rear outriggers	22480 kg	23810 kg
Front and rear dozer blade	22390 kg	23720 kg

AIR CONDITIONING SYSTEM	
The air conditioning system contains fluorinated greenhouse gas refrigerant R134a (Global Warming Potential = 1430). The system contains 0.8 kg of refrigerant representing a CO <sub>2</sub> equivalent of 1.14 metric tonnes.	

# DIMENSIONS & WORKING RANGE

## HW210A MONO BOOM DIMENSIONS

5.65 m Mono Boom, 2.4 m, 2.70 m, 2.92 m Arm, Front Outriggers and Rear Dozer Blade.

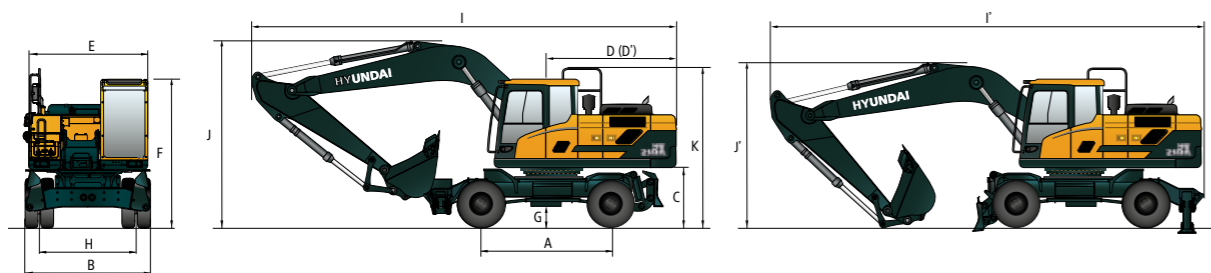

Unit : mm

A	Wheel base	2800
B	Overall width (STD / Wide axle)	2530 / 2700
C	Ground clearance of counterweight	1295
D	Rear-end distance	2733
D'	Rear-end swing radius	2740
E	Upperstructure width	2530
F	Overall height of cab	3260
G	Min. ground clearance	353
H	Tread	1914
K	Overall height of guardrail	3330

Boom length		5650		
Arm length		2400	2700	2920
I	Overall length (Traveling position)	9590	9540	9380
I'	Overall length (Shipping position)	9680	9570	9500
J	Overall height of boom (Traveling position)	3720	3650	4020
J'	Overall height of boom (Shipping position)	3350	3240	3150

# DIMENSIONS & WORKING RANGE

## HW210A 2-PIECE BOOM DIMENSIONS

5.4 m 2-Piece Boom, 2.40 m, 2.70 m, 2.92 m Arm, Rear Dozer Blade

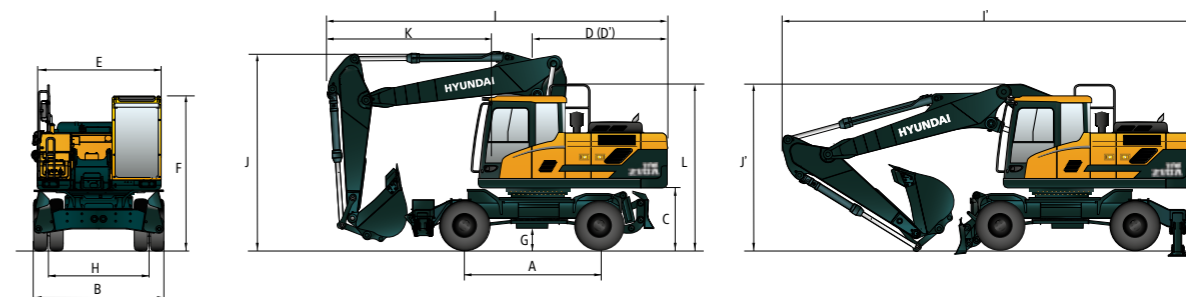

Unit : mm

A	Wheel base	2800
B	Overall width (STD / Wide axle)	2530 / 2700
C	Ground clearance of counterweight	1295
D	Rear-end distance	2733
D'	Rear-end swing radius	2740
E	Upperstructure width	2530
F	Overall height of cab	3260
G	Min. ground clearance	353
H	Tread	1914
L	Overall height of guardrail	3330

Boom length		5400		
Arm length		2400	2700	2920
I	Overall length (Traveling position)	7090	7060	6980
I'	Overall length (Shipping position)	9240	9250	9230
J	Overall height of boom (Traveling position)	3990	3990	3990
J'	Overall height of boom (Shipping position)	3170	3150	3180
K	End of attachment to steering wheel	3610	3580	3500

## HW210A MONO BOOM WORKING RANGE

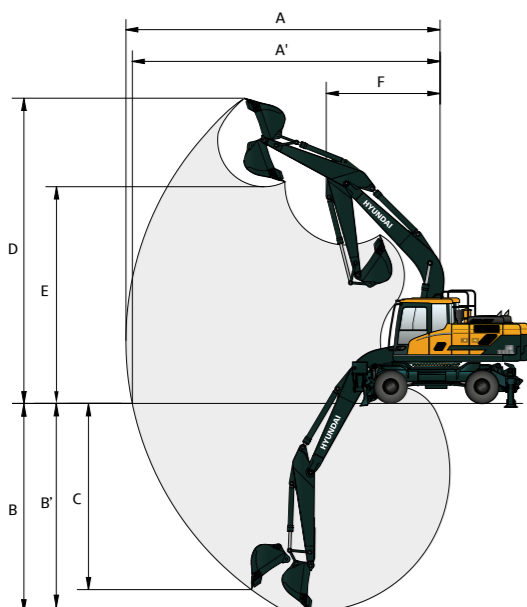

Unit : mm

Boom Length		5650		
Arm Length		2400	2700	2920
A	Max. digging reach	9480	9760	9970
A'	Max. digging reach on ground	9270	9550	9770
B	Max. digging depth	5860	6210	6430
B'	Max. digging depth (8° level)	5660	5980	6210
C	Max. vertical wall digging depth	5510	5830	6110
D	Max. digging height	9710	9870	10020
E	Max. dumping height	6860	7010	7160
F	Min. swing radius	3520	3490	3460

## HW210A 2-PIECE BOOM WORKING RANGE

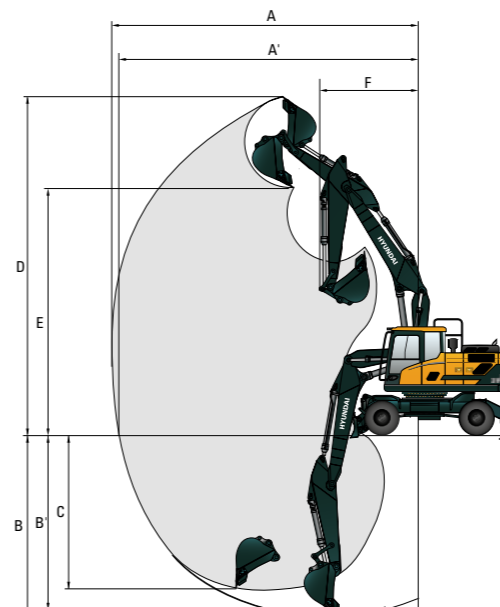

Unit : mm

Boom Length		5400		
Arm Length		2400	2700	2920
A	Max. digging reach	9310	9600	9810
A'	Max. digging reach on ground	9100	9400	9610
B	Max. digging depth	5570	5870	6090
B'	Max. digging depth (8° level)	5470	5770	6000
C	Max. vertical wall digging depth	4630	4580	4730
D	Max. digging height	10300	10520	10690
E	Max. dumping height	7370	7590	7750
F	Min. swing radius	3030	2870	2860

# LIFTING CAPACITY

Rating over-front Rating over-side or 360 degrees

## HW210A MONO BOOM

5.65 m Mono boom, 2.40 m arm equipped with outriggers and dozer blade up

Lift-point height m		Lift-point radius								At max. Reach		
		3.0 m		4.5 m		6.0 m		7.5 m		Capacity	Reach	
										kg	m	
7.5 m	kg									*4820	4670	5.72
6.0 m	kg					*5520	4330			*4400	3410	6.89
4.5 m	kg			*7190	6460	*5960	4180	4330	2910	4240	2850	7.59
3.0 m	kg			*8800	5920	5980	3950	4250	2830	3870	2580	7.94
1.5 m	kg			8890	5500	5750	3730	4140	2730	3760	2480	8.00
0.0 m	kg			8680	5320	5600	3600	4070	2670	3890	2550	7.76
-1.5 m	kg	*11990	10010	8660	5310	5570	3570			4320	2830	7.21
-3.0 m	kg	*11220	10230	*8410	5420	5680	3670			5380	3500	6.25

5.65 m Mono boom, 2.40 m arm equipped with outriggers and dozer blade down

Lift-point height m		Lift-point radius								At max. Reach		
		3.0 m		4.5 m		6.0 m		7.5 m		Capacity	Reach	
										kg	m	
7.5 m	kg									*4820	*4820	5.72
6.0 m	kg					*5520	*5520			*4400	*4400	6.89
4.5 m	kg			*7190	*7190	*5960	5550	*5130	3880	*4300	3800	7.59
3.0 m	kg			*8800	8140	*6640	5310	*5630	3790	*4390	3460	7.94
1.5 m	kg			*10000	7680	*7260	5080	*5870	3690	*4680	3360	8.00
0.0 m	kg			*10280	7480	*7540	4940	*5900	3630	*5240	3460	7.76
-1.5 m	kg	*11990	*11990	*9780	7470	*7290	4910			*5710	3840	7.21
-3.0 m	kg	*11220	*11220	*8410	7600	*6070	5010			*5610	4760	6.25

5.65 m Mono boom, 2.40 m arm equipped with 4 outriggers down

Lift-point height m		Lift-point radius								At max. Reach		
		3.0 m		4.5 m		6.0 m		7.5 m		Capacity	Reach	
										kg	m	
7.5 m	kg									*4820	*4820	5.72
6.0 m	kg					*5520	*5520			*4400	*4400	6.89
4.5 m	kg			*7190	*7190	*5960	*5960	*5130	4570	*4300	*4300	7.59
3.0 m	kg			*8800	*8800	*6640	6310	*5630	4490	*4390	4100	7.94
1.5 m	kg			*10000	9380	*7260	6070	*5870	4380	*4680	3980	8.00
0.0 m	kg			*10280	9170	*7540	5920	*5900	4320	*5240	4120	7.76
-1.5 m	kg	*11990	*11990	*9780	9160	*7290	5890			*5710	4570	7.21
-3.0 m	kg	*11220	*11220	*8410	*8410	*6070	6000			*5610	*5610	6.25

- Lifting capacities are based on ISO 10567.
- Lifting capacity of the HW A-series does not exceed 75% of tipping load with the machine on firm, level ground or 87% of full hydraulic capacity.
- The Lift-point is bucket pivot mounting pin on the arm (without bucket mass).
- (\*) indicates load limited by hydraulic capacity.
- Caution: please be aware of the local regulations and instructions for lifting operations.

# LIFTING CAPACITY

Rating over-front Rating over-side or 360 degrees

## HW210A MONO BOOM

5.65 m Mono boom, 2.92 m arm equipped with outriggers and dozer blade up

Lift-point height m		Lift-point radius										At max. Reach					
		1.5 m		3.0 m		4.5 m		6.0 m		7.5 m		Capacity	Reach				
												kg	m				
7.5 m	kg											*4680	4410		*3140	*3140	6.39
6.0 m	kg					*5020	4390					*2900	*2900	7.45			
4.5 m	kg					*6500	*6500	*5520	4220	4370	2930	*2840	2550	8.10			
3.0 m	kg					*8160	6030	6020	3970	4250	2820	*2890	2320	8.43			
1.5 m	kg					8960	5540	5750	3730	4120	2700	*3070	2240	8.49			
0.0 m	kg					*6650	*6650	8650	5280	5570	3560	4030	2620	*3400	2280	8.27	
-1.5 m	kg	*7190	*7190	*11250	9770	8570	5210	5500	3490	4000	2590	3840	2490	7.75			
-3.0 m	kg	*11870	*11870	*12450	9970	8660	5280	5550	3540			4610	2990	6.86			
-4.5 m	kg			*9040	*9040	*6580	5510					*4960	4290	5.43			

5.65 m Mono boom, 2.92m arm equipped with outriggers and dozer blade down



Lift-point height m		Lift-point radius										At max. Reach					
		1.5 m		3.0 m		4.5 m		6.0 m		7.5 m		Capacity	Reach				
												kg	m				
7.5 m	kg											*4680	*4680		*3140	*3140	6.39
6.0 m	kg					*5020	*5020					*2900	*2900	7.45			
4.5 m	kg					*6500	*6500	*5520	*5520	*5030	3910	*2840	*2840	8.10			
3.0 m	kg					*8160	*8160	*6270	5340	*5340	3800	*2890	*2890	8.43			
1.5 m	kg					*9580	7740	*6990	5080	*5680	3670	*3070	3050	8.49			
0.0 m	kg					*6650	*6650	*10180	7460	*7420	4910	*5850	3580	*3400	3120	8.27	
-1.5 m	kg	*7190	*7190	*11250	*11250	*9980	7380	*7370	4840	*5620	3560	*4010	3410	7.75			
-3.0 m	kg	*11870	*11870	*12450	*12450	*8950	7460	*6600	4880			*5240	4090	6.86			
-4.5 m	kg			*9040	*9040	*6580	*6580					*4960	*4960	5.43			

5.65 m Mono boom, 2.92 m arm equipped with 4 outriggers down

Lift-point height m		Lift-point radius										At max. Reach					
		1.5 m		3.0 m		4.5 m		6.0 m		7.5 m		Capacity	Reach				
												kg	m				
7.5 m	kg											*4680	*4680		*3140	*3140	6.39
6.0 m	kg					*5020	*5020					*2900	*2900	7.45			
4.5 m	kg					*6500	*6500	*5520	*5520	*5030	4610	*2840	*2840	8.10			
3.0 m	kg					*8160	*8160	*6270	*6270	*5340	4490	*2890	*2890	8.43			
1.5 m	kg					*9580	9450	*6990	6080	*5680	4360	*3070	*3070	8.49			
0.0 m	kg					*6650	*6650	*10180	9150	*7420	5890	*5850	4270	*3400	*3400	8.27	
-1.5 m	kg	*7190	*7190	*11250	*11250	*9980	9070	*7370	5820	*5620	4240	*4010	*4010	7.75			
-3.0 m	kg	*11870	*11870	*12450	*12450	*8950	*8950	*6600	5870			*5240	4880	6.86			
-4.5 m	kg			*9040	*9040	*6580	*6580					*4960	*4960	5.43			











- Lifting capacities are based on ISO 10567.
- Lifting capacity of the HW A-series does not exceed 75% of tipping load with the machine on firm, level ground or 87% of full hydraulic capacity.
- The Lift-point is bucket pivot mounting pin on the arm (without bucket mass).
- (\*) indicates load limited by hydraulic capacity.
- Caution: please be aware of the local regulations and instructions for lifting operations.

# LIFTING CAPACITY











 Rating over-front  Rating over-side or 360 degrees

## HW210A 2-PIECE BOOM











5.4 m 2-Piece boom, 2.40 m arm equipped with outriggers and dozer blade up

Lift-point height m	kg	Lift-point radius								At max. Reach		
		3.0 m		4.5 m		6.0 m		7.5 m		Capacity	Reach	
												m
7.5 m	kg			*4680	*4680					*5110	*5110	5.48
6.0 m	kg			*4810	*4810	*4800	4750			*4720	3930	6.69
4.5 m	kg	*7890	*7890	*5910	*5910	*5170	4620			*4510	3290	7.41
3.0 m	kg			*7600	6620	*5920	4410	4680	3170	4420	2990	7.77
1.5 m	kg			*9200	6210	6370	4210	4590	3080	4310	2900	7.83
0.0 m	kg			9640	6010	6220	4080	4540	3040	4470	2990	7.59
-1.5 m	kg	*12480	11210	9620	6000	6200	4060			5000	3340	7.02

5.4 m 2-Piece boom, 2.40 m arm equipped with outriggers and dozer blade down



Lift-point height m	kg	Lift-point radius								At max. Reach		
		3.0 m		4.5 m		6.0 m		7.5 m		Capacity	Reach	
												m
7.5 m	kg			*4680	*4680					*5110	*5110	5.48
6.0 m	kg			*4810	*4810	*4800	*4800			*4720	*4720	6.69
4.5 m	kg	*7890	*7890	*5910	*5910	*5170	*5170			*4510	4330	7.41
3.0 m	kg			*7600	*7600	*5920	5850	*5290	4190	*4520	3960	7.77
1.5 m	kg			*9200	8540	*6740	5640	*5660	4100	*4740	3860	7.83
0.0 m	kg			*10120	8330	*7360	5500	*5950	4050	*5210	3990	7.59
-1.5 m	kg	*12480	*12480	*10310	8310	*7570	5480			*6130	4460	7.02

5.4 m 2-Piece boom, 2.40 m arm equipped with 4 outriggers down

Lift-point height m	kg	Lift-point radius								At max. Reach		
		3.0 m		4.5 m		6.0 m		7.5 m		Capacity	Reach	
												m
7.5 m	kg			*4680	*4680					*5110	*5110	5.48
6.0 m	kg			*4810	*4810	*4800	*4800			*4720	*4720	6.69
4.5 m	kg	*7890	*7890	*5910	*5910	*5170	*5170			*4510	*4510	7.41
3.0 m	kg			*7600	*7600	*5920	*5920	*5290	4920	*4520	*4520	7.77
1.5 m	kg			*9200	*9200	*6740	6690	*5660	4830	*4740	4540	7.83
0.0 m	kg			*10120	*10120	*7360	6550	*5950	4780	*5210	4710	7.59
-1.5 m	kg	*12480	*12480	*10310	10120	*7570	6520			*6130	5270	7.02











- Lifting capacities are based on ISO 10567.
- Lifting capacity of the HW A-series does not exceed 75% of tipping load with the machine on firm, level ground or 87% of full hydraulic capacity.
- The Lift-point is bucket pivot mounting pin on the arm (without bucket mass).
- (\*) indicates load limited by hydraulic capacity.
- Caution: please be aware of the local regulations and instructions for lifting operations.

# LIFTING CAPACITY











 Rating over-front  Rating over-side or 360 degrees

## HW210A 2-PIECE BOOM











5.4 m 2-Piece boom, 2.92 m arm equipped with outriggers and dozer blade up

Lift-point height m	kg	Lift-point radius								At max. Reach		
		3.0 m		4.5 m		6.0 m		7.5 m		Capacity	Reach	
												m
9.0 m	kg									*4500	*4500	4.31
7.5 m	kg					*4450	*4450			*3510	*3510	6.17
6.0 m	kg					*4230	*4230			*3160	*3160	7.27
4.5 m	kg			*5190	*5190	*4680	4670	*4560	3260	*3030	2940	7.93
3.0 m	kg			*6890	6740	*5480	4440	4690	3170	*3040	2700	8.27
1.5 m	kg			*8620	6260	*6370	4210	4570	3060	*3180	2620	8.33
0.0 m	kg	*6800	*6800	9620	5990	6190	4040	4490	2980	*3470	2690	8.10
-1.5 m	kg	*11610	11010	9530	5910	6120	3980	4490	2980	*4010	2950	7.57
-3.0 m	kg			9620	5990	6190	4040					

5.4 m 2-Piece boom, 2.92 m arm equipped with outriggers and dozer blade down

Lift-point height m	kg	Lift-point radius								At max. Reach		
		3.0 m		4.5 m		6.0 m		7.5 m		Capacity	Reach	
												m
9.0 m	kg									*4500	*4500	4.31
7.5 m	kg					*4450	*4450			*3510	*3510	6.17
6.0 m	kg					*4230	*4230			*3160	*3160	7.27
4.5 m	kg			*5190	*5190	*4680	*4680	*4560	4290	*3030	*3030	7.93
3.0 m	kg			*6890	*6890	*5480	*5480	*4890	4190	*3040	*3040	8.27
1.5 m	kg			*8620	8600	*6370	5640	*5350	4080	*3180	*3180	8.33
0.0 m	kg	*6800	*6800	*9780	8300	*7100	5470	*5750	4000	*3470	*3470	8.10
-1.5 m	kg	*11610	*11610	*10240	8220	*7480	5400	*5030	4000	*4010	3950	7.57
-3.0 m	kg			*9920	8310	*7230	5470					

5.4 m 2-Piece boom, 2.92 m arm equipped with 4 outriggers down

Lift-point height m	kg	Lift-point radius								At max. Reach		
		3.0 m		4.5 m		6.0 m		7.5 m		Capacity	Reach	
												m
9.0 m	kg									*4500	*4500	4.31
7.5 m	kg					*4450	*4450			*3510	*3510	6.17
6.0 m	kg					*4230	*4230			*3160	*3160	7.27
4.5 m	kg			*5190	*5190	*4680	*4680	*4560	*4560	*3030	*3030	7.93
3.0 m	kg			*6890	*6890	*5480	*5480	*4890	*4890	*3040	*3040	8.27
1.5 m	kg			*8620	*8620	*6370	*6370	*5350	4810	*3180	*3180	8.33
0.0 m	kg	*6800	*6800	*9780	*9780	*7100	6520	*5750	4730	*3470	*3470	8.10
-1.5 m	kg	*11610	*11610	*10240	10030	*7480	6450	*5030	4730	*4010	*4010	7.57
-3.0 m	kg			*9920	*9920	*7230	6520					

- Lifting capacities are based on ISO 10567.
- Lifting capacity of the HW A-series does not exceed 75% of tipping load with the machine on firm, level ground or 87% of full hydraulic capacity.
- The Lift-point is bucket pivot mounting pin on the arm (without bucket mass).
- (\*) indicates load limited by hydraulic capacity.
- Caution: please be aware of the local regulations and instructions for lifting operations.

# BUCKET SELECTION GUIDE & DIGGING FORCE

## BUCKETS



SAE heaped m <sup>3</sup>	0.80	■ 0.85
	0.86	■ 1.00
	0.92	■ 1.15
	1.20	
	1.34	

Capacity m <sup>3</sup>		Width mm	Weight kg	Tooth EA	Recommendation mm					
SAE heaped	CECE heaped				5650 Mono Boom			5400 2-Piece Boom		
					2400 Arm	2700 Arm	2920 Arm	2400 Arm	2700 Arm	2920 Arm
0.80	0.70	1070	770	5	○	○	■	●	●	●
0.86	0.75	1140	740	5	○	■	■	●	●	○
0.92	0.80	1190	820	5	■	■	▲	●	●	○
1.20	1.05	1390	920	5	▲	X	X	■	■	▲
1.34	1.17	1525	990	6	X	X	X	▲	▲	▲
■ 0.85	0.76	960	860	4	○	■	■	●	●	●
■ 1.00	0.89	1110	950	5	■	▲	▲	○	○	■
■ 1.15	1.01	1260	1030	6	▲	X	X	■	■	▲

- Heavy Duty
- Applicable for materials with density of 2100 kg/m<sup>3</sup> or less
- Applicable for materials with density of 1800 kg/m<sup>3</sup> or less
- Applicable for materials with density of 1500 kg/m<sup>3</sup> or less
- ▲ Applicable for materials with density of 1200 kg/m<sup>3</sup> or less
- X Not Recommended

## ATTACHMENT

Booms and arms are welded with a low-stress, full-box section design. 5.65 m Mono boom, 5.40 m 2-Piece boom and 2.4 m, 2.7 m, 2.92 m arms are available.

## DIGGING FORCE

Boom	Length	mm	5650 Mono boom			5400 2-Piece boom			Remark
			2400	2700	2920	2400	2700	2920	
Bucket digging force	SAE	kN	130.4 [141.6]	130.4 [141.6]	130.4 [141.6]	130.4 [141.6]	130.4 [141.6]	130.4 [141.6]	[ ] : Power Boost
		kgf	13300 [14440]	13300 [14440]	13300 [14440]	13300 [14440]	13300 [14440]	13300 [14440]	
	ISO	kN	151.0 [164.0]	151.0 [164.0]	151.0 [164.0]	151.0 [164.0]	151.0 [164.0]	151.0 [164.0]	
		kgf	15400 [16720]	15400 [16720]	15400 [16720]	15400 [16720]	15400 [16720]	15400 [16720]	
Arm crowd force	SAE	kN	120.6 [130.9]	108.9 [118.2]	102.0 [110.7]	120.6 [130.9]	108.9 [118.2]	102.0 [110.7]	
		kgf	12300 [13350]	11100 [12050]	10400 [11290]	12300 [13350]	11100 [12050]	10400 [11290]	
	ISO	kN	126.5 [137.4]	113.8 [123.5]	106.9 [116.1]	126.5 [137.4]	113.8 [123.5]	106.9 [116.1]	
		kgf	12900 [14010]	11600 [12590]	10900 [11830]	12900 [14010]	11600 [12590]	10900 [11830]	

Note : Boom weight includes arm cylinder, piping, and pin  
 Arm weight includes bucket cylinder, linkage, and pin

# STANDARD/OPTIONAL EQUIPMENT

ENGINE	STD
Cummins B6.7 engine	●
HYDRAULIC SYSTEM	STD
<b>EPFC (Electronic Pump Flow Control)</b>	
Variable Power Control	●
3-power modes, 3-work modes, user mode	●
Attachment Flow Control	●
3 attachment control modes (Push/Prop./Permanent)	●
Engine Auto Idling	●
Engine Auto Shutdown	●
Electronic Fan Control (reversible)	●
35 km/h or 20 km/h travel motor	●
Hyundai Bio Hydraulic Oil (HBHO)	●
CABIN & INTERIOR	STD
<b>ISO Standard cabin</b>	
All-weather steel cabin with 360° visibility	●
Parallel type windshield wiper	●
Radio / USB / MP3 player	●
Handsfree mobile phone system with USB	●
12 volt power outlet (24V DC to 12V DC converter)	●
Electric horn	●
Safety glass - Tempered glass	●
Safety glass - Tempered glass with front laminated glass	●
Safety glass windows	●
Sliding fold-in front window	●
Sliding side window (LH)	●
Lockable door	●
Hot & cool box	●
Storage compartment	●
Transparent cabin roof-cover	●
Cabin light	●
Cabin front window rain guard	●
Sun visor	●
Door and cab locks, one key	●
Smart key & Start button	●
Pilot-operated proportional joysticks	●
Steering wheel with 3-way adjustable steering column	●
Console box height adjust system	●
<b>Automatic climate control</b>	
Air conditioner & heater	●
Defroster	●
Starting Aid (air grid heater) for cold weather	●
<b>Centralised monitoring</b>	
8" LCD touchscreen display	●
Engine speed or trip meter/Accel.	●
Engine coolant temperature gauge	●
Max power	●
Low speed/High speed	●
Auto idle	●
Overload warning with alarm	●
Check Engine	●
Air cleaner clogging	●
Indicators	●
ECO Gauges	●
Fuel level gauge	●
Hyd. oil temperature gauge	●
Fuel warmer	●
Warnings	●
Communication error	●
Low battery	●
Clock	●
<b>Seat</b>	
Adjustable air suspension seat with heater	●
Mechanical suspension seat with heater	●
<b>Cabin ROPS (ISO 12117-2)</b>	
ROPS (Roll Over Protective Structure)	●
<b>Cabin FOPS/FOG (ISO 10262) Level 2</b>	
FOPS (Falling Object Protective Structure)	●
FOG (Falling Object Guard)	Front & Top Guard Top Guard

SAFETY	STD
Safety lock valve on boom cylinders with overload warning device	●
Safety lock valve on arm cylinder	●
Safety lock valve on dozer blade and ram lock cylinders	●
Four outside rearview mirrors	●
Rearview camera	●
Rear & Mirrorview camera	●
Rear Radar & 2nd monitor	●
AAVM (Advanced Around View Monitoring)	●
Four front working lights LED (2 boom mounted, 2 front frame mounted)	●
Rear work lamp LED	●
Beacon lamp LED	●
Travel alarm	●
Automatic swing brake	●
Swing Lock System	●
Auto-digging brake	●
Joystick Steering	●
Battery master switch	●
Boom holding system	●
Arm holding system	●
General type guardrail	●
Separable type guardrail	●

ATTACHMENT	STD
<b>Boom options</b>	
5.65 m Mono	●
5.40 m 2-Piece	●
<b>Arm options</b>	
2.4 m	●
2.92 m	●

OTHER	STD
Heavy counterweight	●
Removable clean-out dust net for cooler	●
Fuel pre-filter	●
Fuel Warmer (Single)	●
Self-diagnostics system	●
Hi-MATE (Remote Management System)	Mobile Satellite
Batteries (2 x 12V x 100 AH)	●
Fuel filler pump (50 lpm) with autostop	●
Compressor with air-pistol in cabin	●
Single-acting piping kit (breaker, etc.)	●
Double-acting piping kit (clamshell, etc.)	●
Rotating Piping Kit	●
Quick coupler piping	●
Quick coupler	●
Bucket-Clamshell adaptation (3-way valve)	●
Accumulator for lowering work equipment	●
Pattern change valve (2 patterns)	●
Automatic digging brake	●
Joystick steering	●
Fine Swing Control System	●
Tool kit	●
Cruise control	●
Speed Limiter	●
Creep speed travel mode	●

UNDERCARRIAGE	STD
Front outrigger and rear blade	●
Front and rear outrigger	●
Front blade and rear outrigger	●
Front grab rest and rear dozer blade	●
Tires-dual (10.00-20-14PR tube)	●
Tires-dual (10.00-20-16PR tube)	●
Tires-dual (10.00-20 solid)	●
Steel fenders (mudguards)	●
Wide axle 2.7 m	●

\* Standard and optional equipment may vary. Contact your Hyundai dealer for more information.  
 \* The machine may vary according to International standards.  
 \* The photos may include attachments and optional equipment that are not available in your area.  
 \* Materials and specifications are subject to change without advance notice.





Specifications and design are subject to change without notice. Pictures of Hyundai Construction Equipment Europe products may show other than standard equipment.

Hyundai Construction Equipment Europe nv,  
Hyundailaan 4, 3980 Tessenderlo, Belgium.  
Tel: (32) 14-56-2200 Fax: (32) 14-59-3405

EN-2021\_06 Rev 0

**Ready to aim high?**

**Contact your Hyundai dealer.**  
[hyundai-ce.eu/en/dealer-locator](https://hyundai-ce.eu/en/dealer-locator)